



# building basics

## link lingo



**Y**

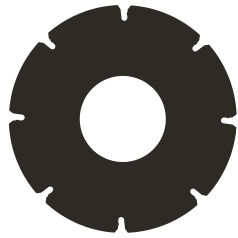

**O**



**X**



**hub**



**90°**



**135°**



**line**



**dot**

---

## good to know

**YOXO is pronounced "yock-so".**

**YOXO pieces are called links.**

**Links come in many colors, shapes and sizes.**

**Links fit together in endless ways.**

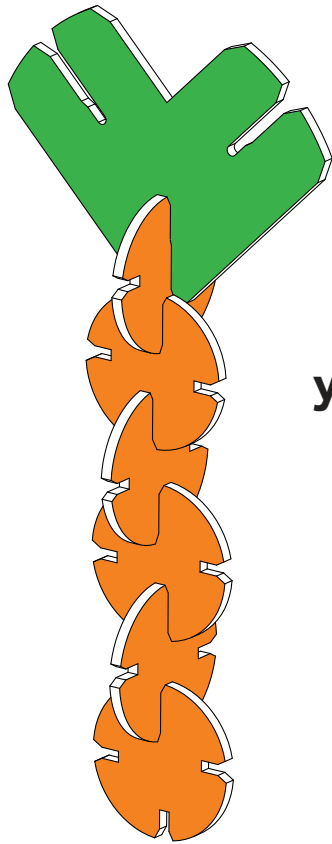

you can build something  
**simple**

or you can  
build something  
**complex**

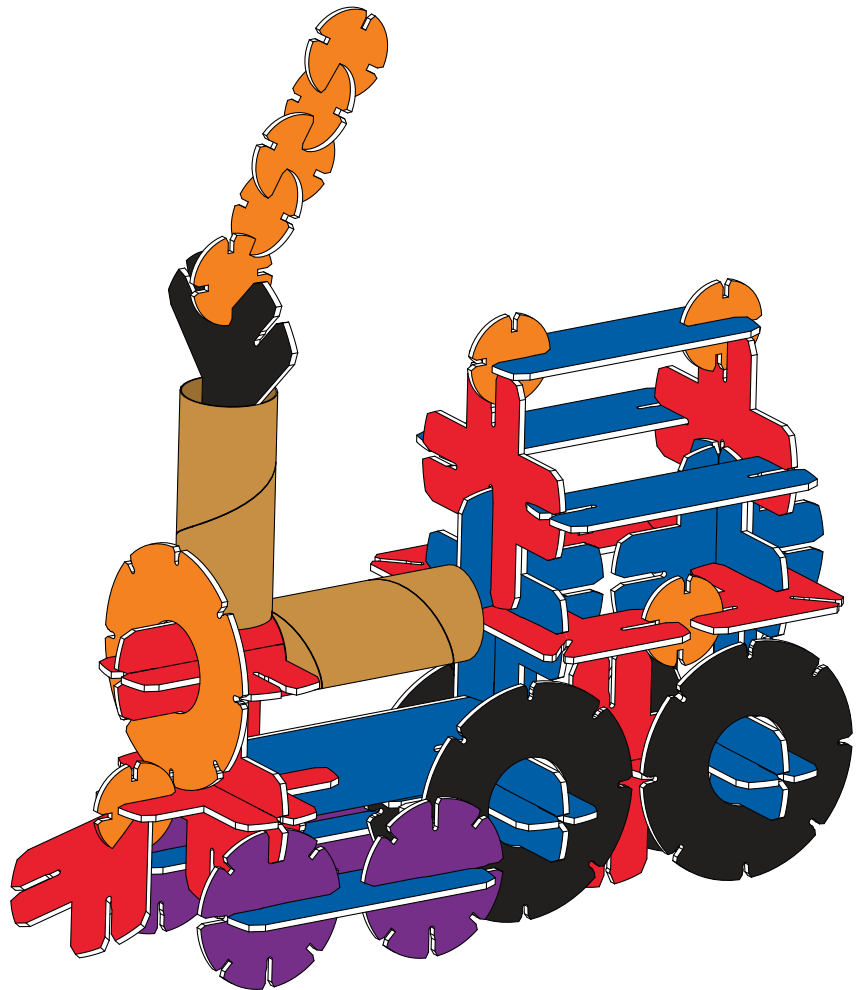

# link connections

There's no wrong way to YOXO,  
but some connections are stronger than others.

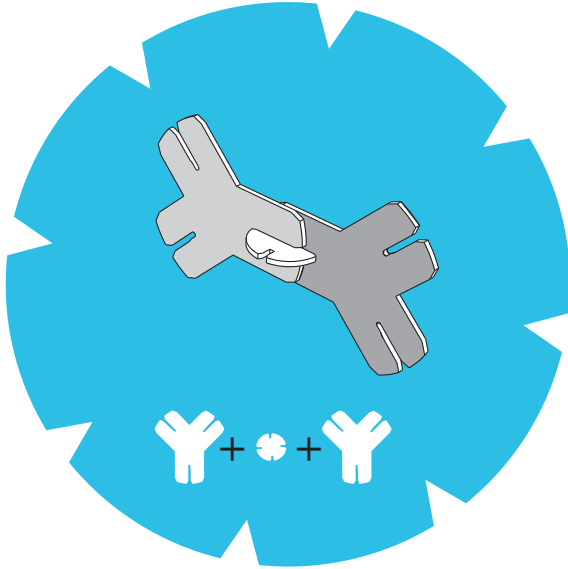

**any two links + a dot**

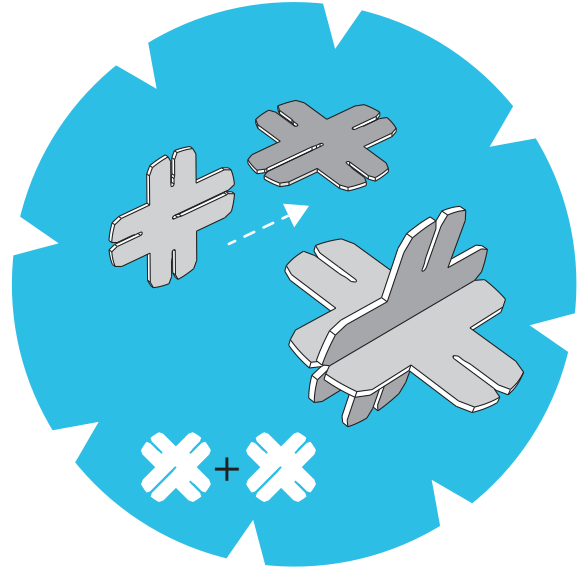

**any two links  
connected slot to slot**

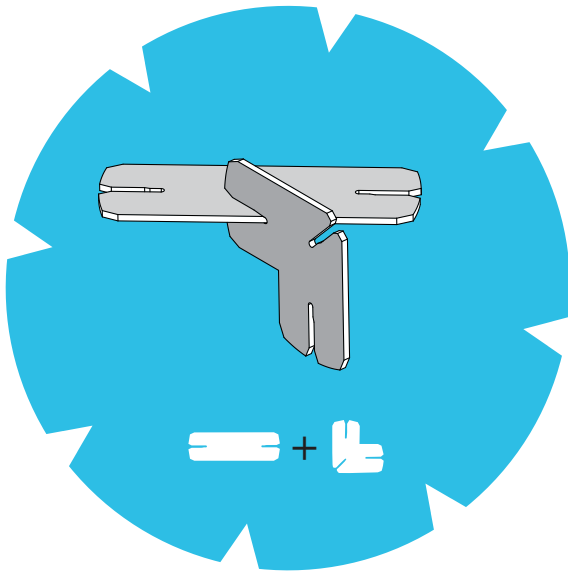

**any link slot connected  
to any link edge**

**Push links together  
until you can't  
push any farther!**

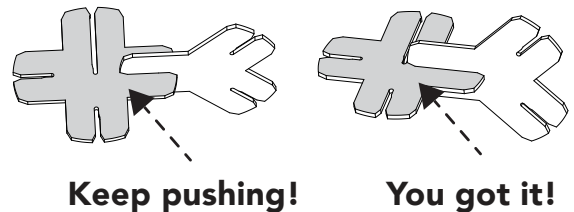

# tube connections

Always use two links inside a tube!

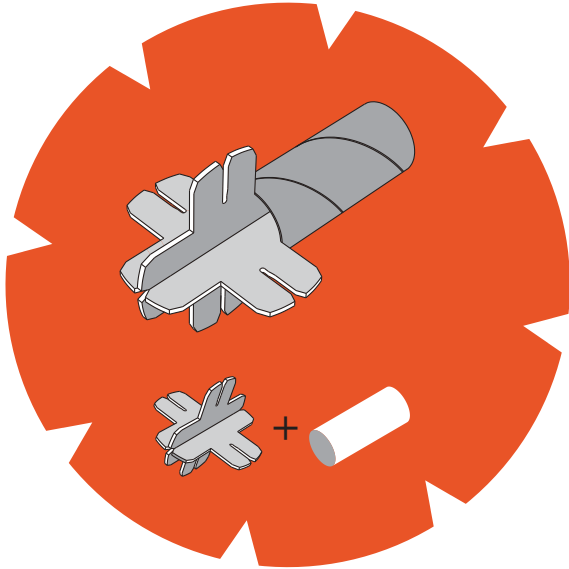

**two X links + a tube**

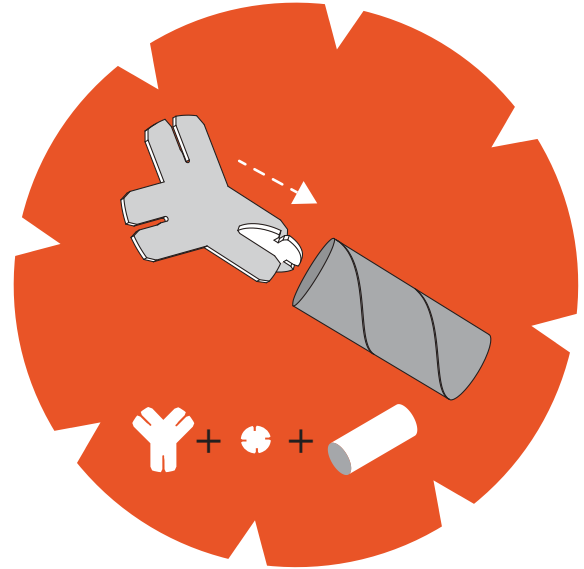

**any link + a dot + a tube**

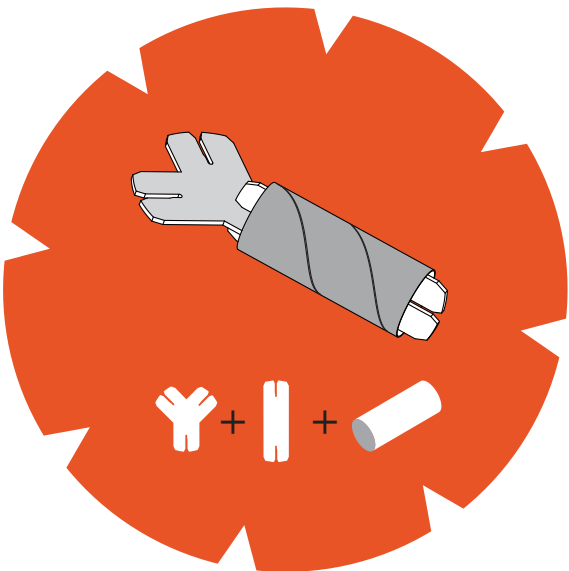

**any link + a line + a tube**

## cereal box connections

You can use the whole box,  
or just cut out what you need.

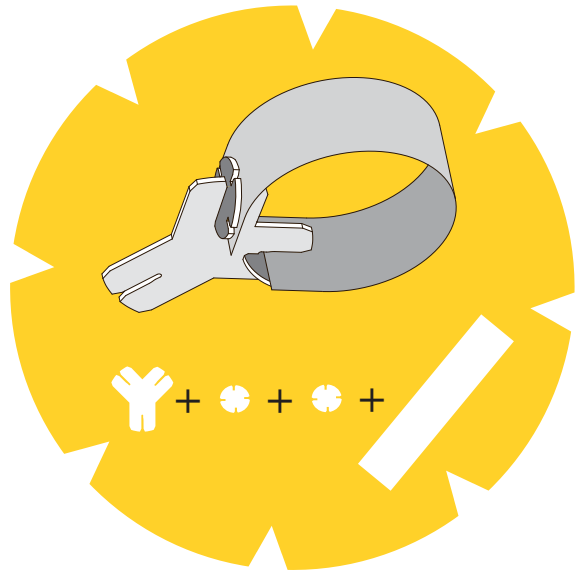
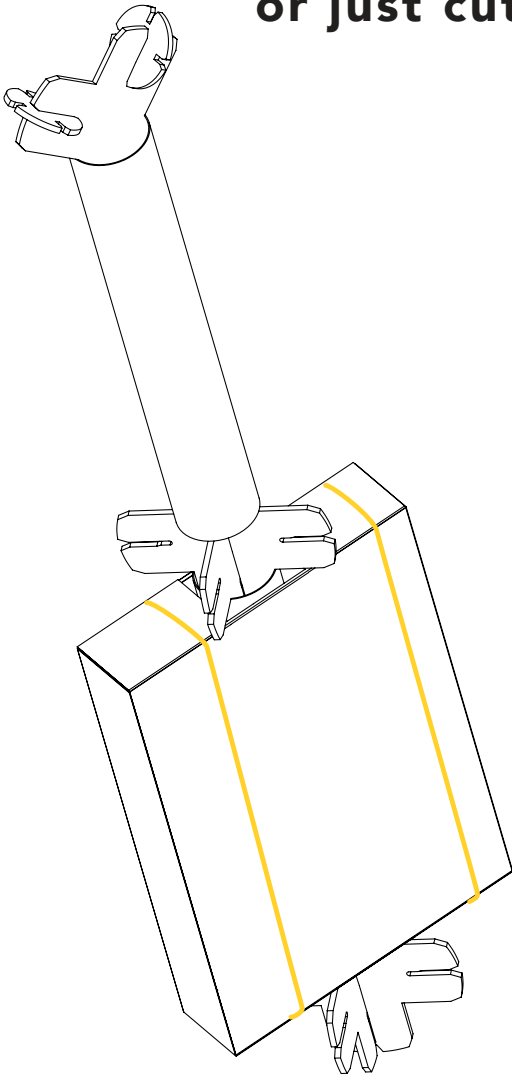

---

**Add different shapes to your builds!**

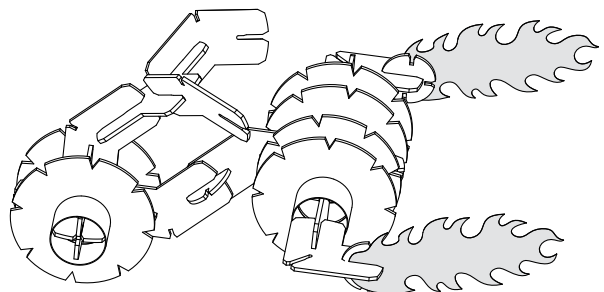
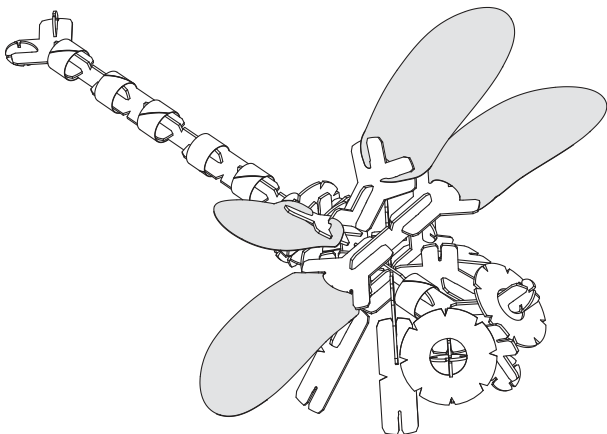

**even more connections**

**YOXO connects to popular  
building toys like LEGO®**

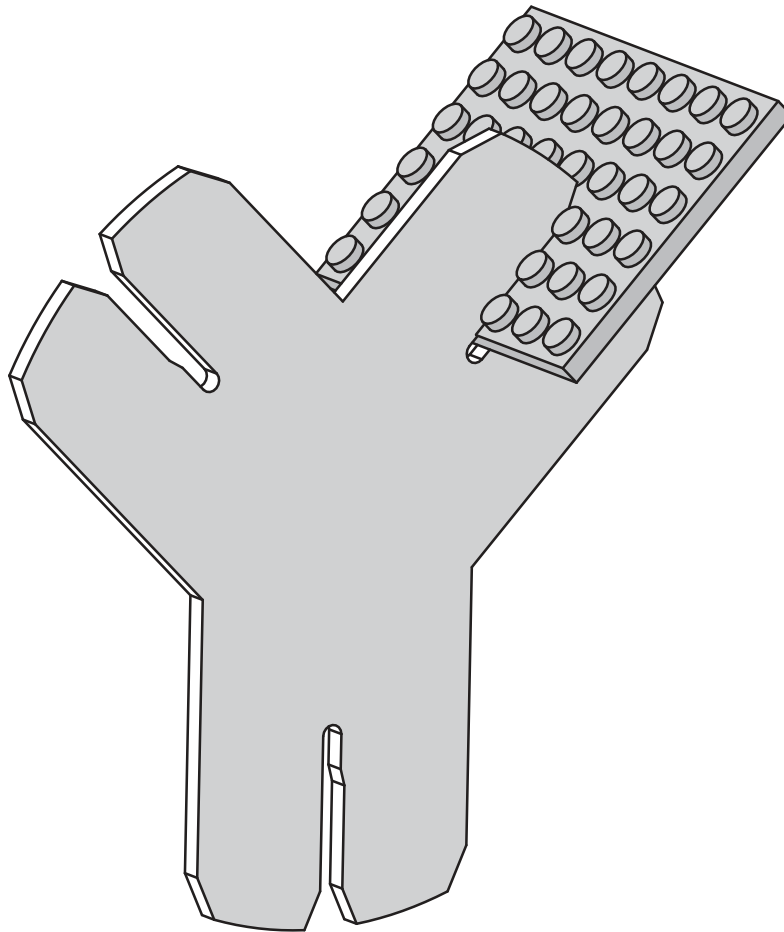

---

**YOXO.com @YOXOtoys #builditYOXO**

©2016 Play from Scratch LLC. All rights reserved. YOXO®, the YOXO logo and Play from Scratch® are registered trademarks of Play from Scratch LLC.  
The YOXO Y and all related images, designs and product configurations are copyrights and trademarks of Play from Scratch LLC.  
LEGO® is a registered trademark of the LEGO Group and is not affiliated with YOXO. PATENT(S) YOXO.COM/PATENTS